

# MEMS: Microelectromechanical Systems

## What are MEMS?

- Micro-electro-mechanical systems
- miniaturized mechanical and electro-mechanical elements
- having some sort of mechanical functionality
- Convert between measured mechanical signals and electrical signals

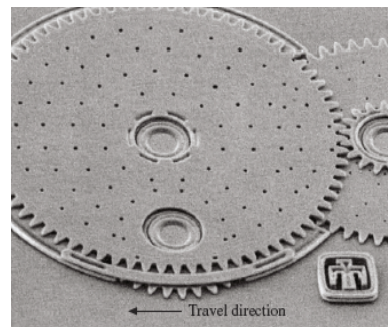
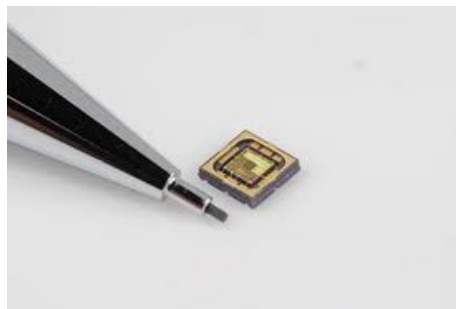

## Fundamentals of MEMS Devices

- Silicon
  - Already in use
  - Manipulatable conductivity
  - Allows for integration
- Thin-Film Materials
  - Silicon dioxide
  - Silicon nitride

## Micromachining Fabrication

- Thin Films
  - Layers ( $\mu\text{m}$ ) put on Si
  - Photomask
    - Positive or negative
- Wet Etching
  - Isotropic
  - Anisotropic
  - KOH

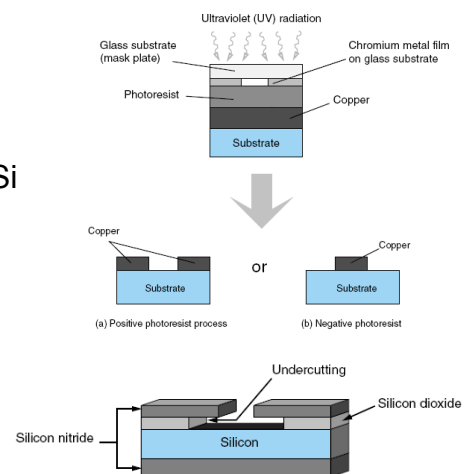

## Micromachining Fabrication II

- Dry Etching

- RIE
- DRIE

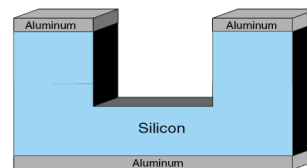

- Rate-Modified Etching

- Cover with Boron
- Wet etch with KOH

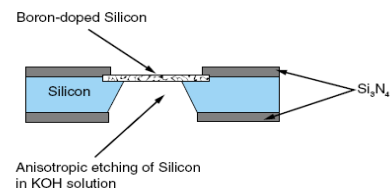

## Surface Micromachining

- Grow silicon dioxide
- Apply photoresist
- Expose and develop
- Etch silicon dioxide
- Remove photoresist
- Deposit polysilicon
- Remove silicon dioxide

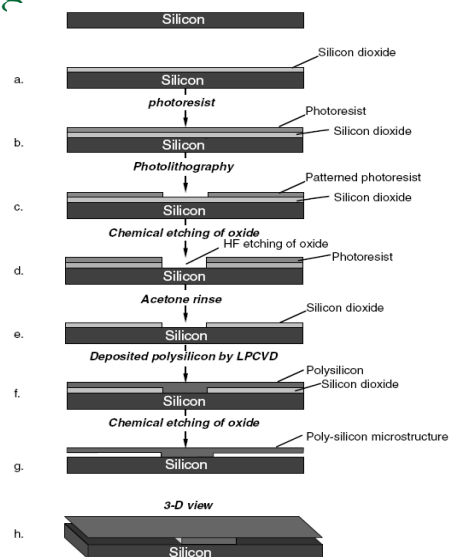

## MEMS Packaging

### ■ Purposes

- Reduce EMI
- Dissipate Heat
- Minimize CTE
- Deliver Required Power
- Survive Environment

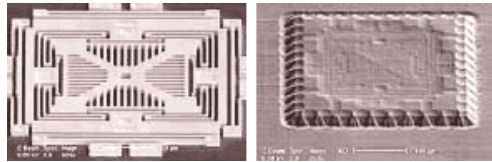

CSE/EE 474

7

## Types of MEMS Packages

### ■ Ceramic Packaging

- Hermetic when sealed
- High Young's Modulus
- Flip Chip or Wirebonding

### ■ Plastic Packaging

- Not Hermetic
- Postmolding
- Premolding

### ■ Metal Packaging

- Hermetic when sealed
- Easy to assemble
- Low Pin Count

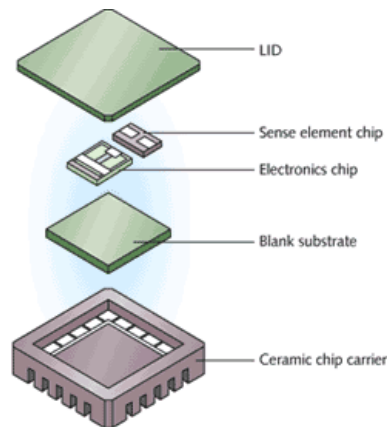

CSE/EE 474

8

## Typical MEMS Devices

- **Sensors**
  - Pressure Sensors
  - Accelerometers
- **Actuators**
  - Gyroscopes
  - High Aspect Ratio Electrostatic Resonators
  - Thermal Actuators
  - Magnetic Actuators
  - Comb-drives

## Typical MEMS Devices

- **Sensors**
  - Pressure Sensors
  - Accelerometers ←
- **Actuators**
  - Gyroscopes ←
  - High Aspect Ratio Electrostatic Resonators
  - Thermal Actuators
  - Magnetic Actuators
  - Comb-drives

## Accelerometers

### Applications:

- Air bag crash sensors
- Active suspension systems
- Antilock brake systems
- Ride control systems
- Smartphones

### Units of mV/g

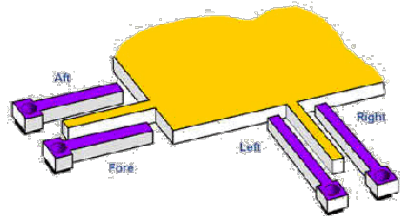

## MEMS Accelerometer

### Mass, Spring, Damper Model

$$F = M \cdot \frac{d^2x}{dt^2} + D \cdot \frac{dx}{dt} + K \cdot x$$

external force
proof mass inertia
damping force
mechanical restoring force

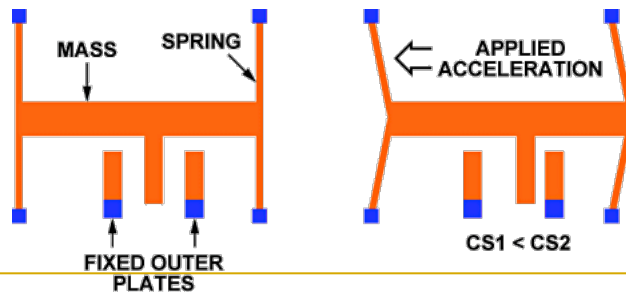
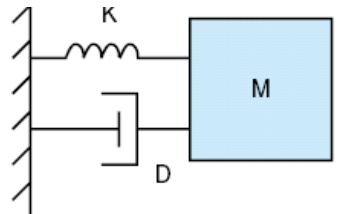

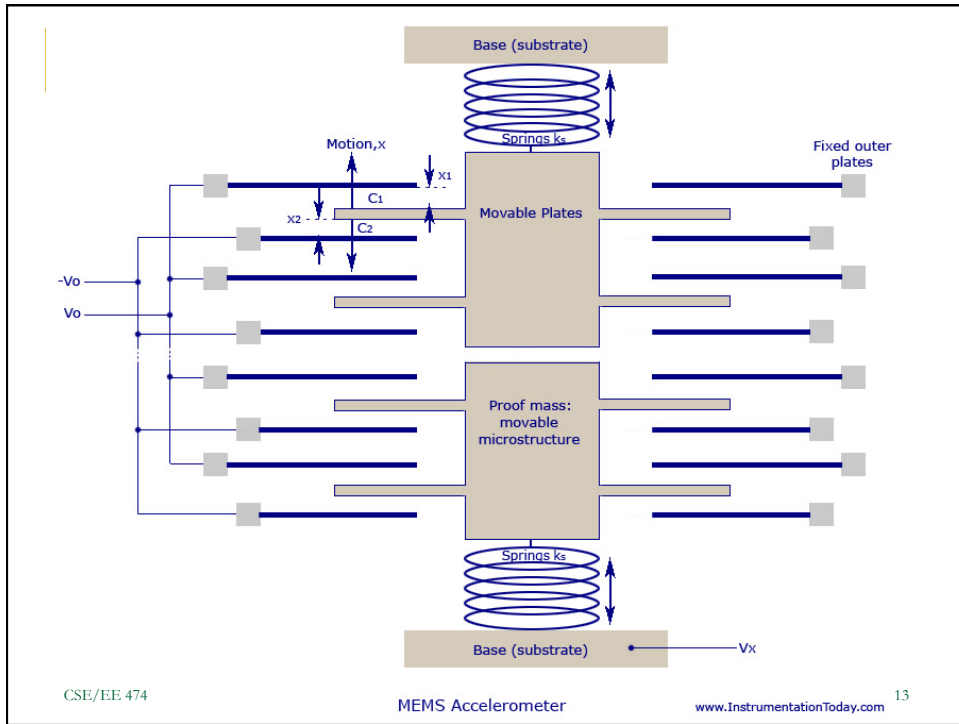

## MEMS Accelerometer (cont' d)

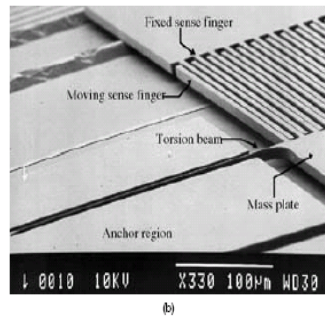
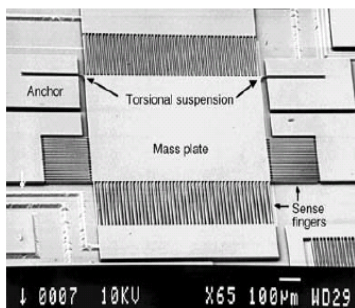
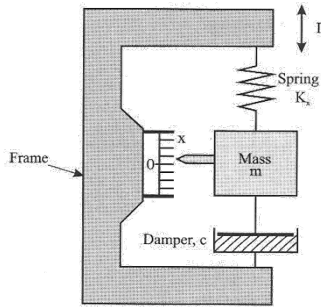

FIGURE 14.18 (a) SEM view of a silicon-on-glass torsional MEMS accelerometer; (b) close-up of the torsional beam and the sense fingers. (Courtesy of Prof. Khalil Najafi, University of Michigan)

## Accelerometer Principle

- mass-spring type accelerometer



$$F = m \left( \frac{d^2x}{dt^2} \right) + c \left( \frac{dx}{dt} \right) + Kx$$

where  
 $x$  = displacement from the rest position of the mass  
 $c$  = damping coefficient  
 $K$  = spring stiffness

if  $c \left( \frac{dx}{dt} \right) = 0$

$$m = -\frac{m}{K}a$$

- To increase accelerometer sensitivity :  $m$  large or  $K$  small

## Accelerometer Principle

- Analog Devices ADXL202
  - surface-micromachined accelerometer

- Sensor Principle  $x = -\frac{m}{K}a$

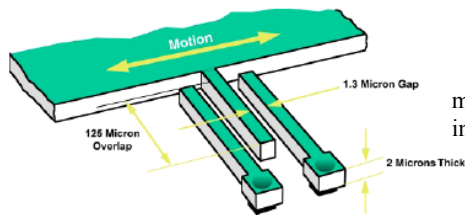

Figure 1. Beam Dimensions for a Single Finger.

measure capacitance, which is inversely proportional to the gap

$$C = \frac{\epsilon A}{d}$$

- To increase accelerometer sensitivity :
  - large  $m$ , small  $K$ , large  $A$

$\epsilon$  : permittivity  
 $A$  : contact area



## ADXL 202 Dual Axis Accelerometers

- To increase the mass, common beam mass is used

x direction acceleration is detected here

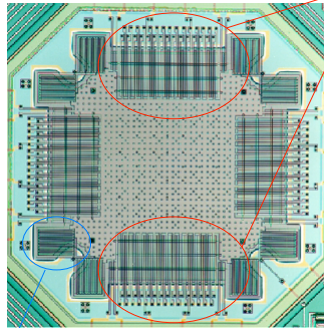

spring

## MEMS Gyroscopes

- Typically Vibratory Gyroscopes
  - Utilize Coriolis Acceleration (“fictional force”)
  - Due to rotating reference frame

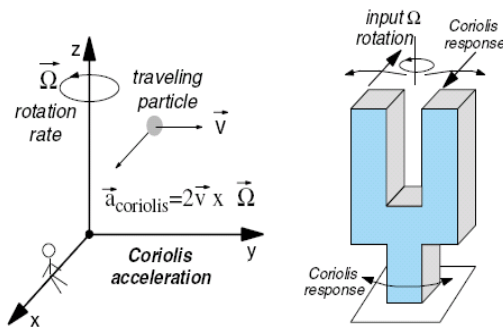

## Coriolis force

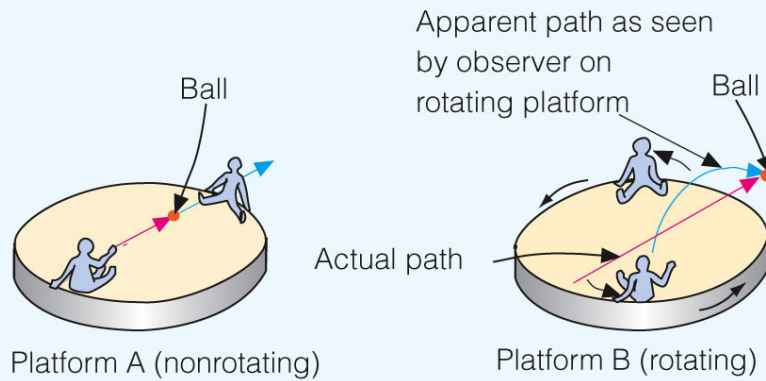

© 2007 Thomson Higher Education

## Coriolis force

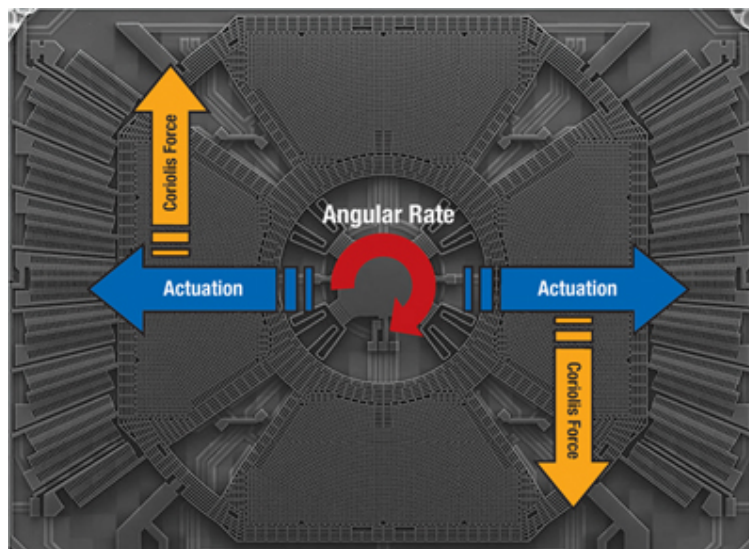

## Types of Vibratory Gyroscopes

Vibrating Beam, Vibrating Disk, Vibrating Shell

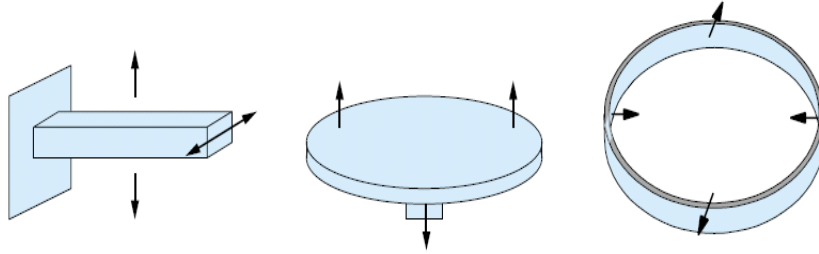

CSE/EE 474

21

## Gyroscope

- Gyroscopic Precession
  - What will happen if there is rotation around the rotation axis

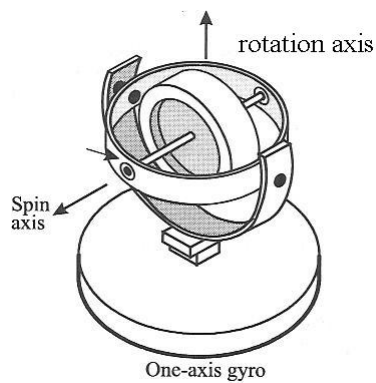

CSE/EE 474

22

## Coriolis Acceleration

- Coriolis acceleration

- A person moving northward toward the outer edge of a rotating platform must increase the westward speed component (blue arrows) to maintain a northbound course. The acceleration required is the Coriolis acceleration.

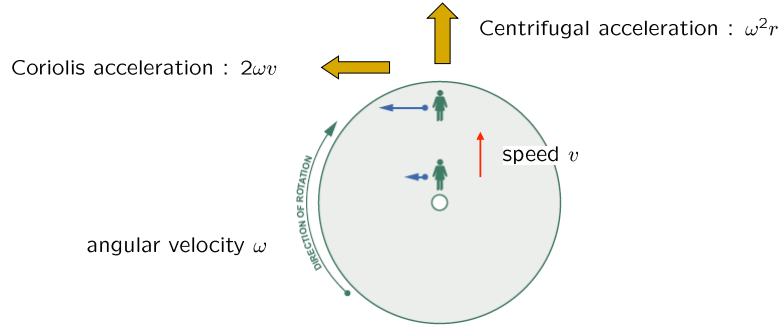

## Coriolis Acceleration

- Constrained motion means force is applied

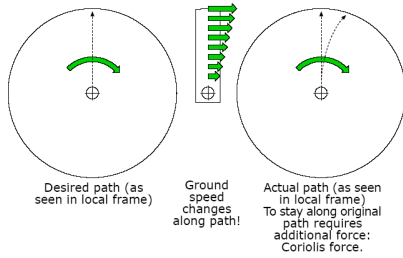

turning fork gyroscope

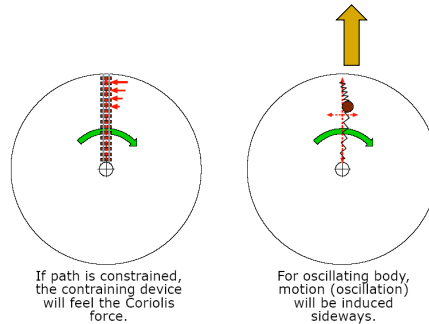
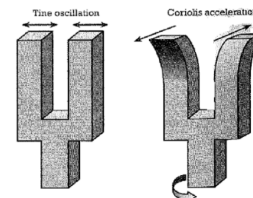

## Gyroscope using Coriolis effect

- Schematic of the gyro's mechanical structure

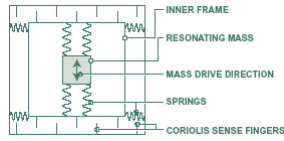

- The displacement is proportional to the rotation speed

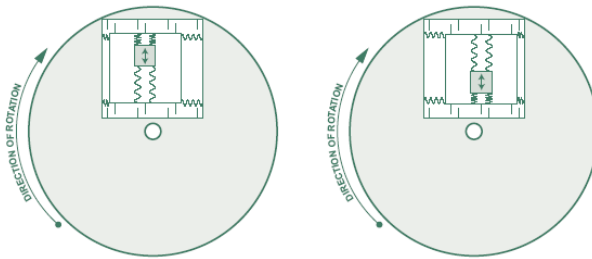

## Disc Resonating Gyro Basics

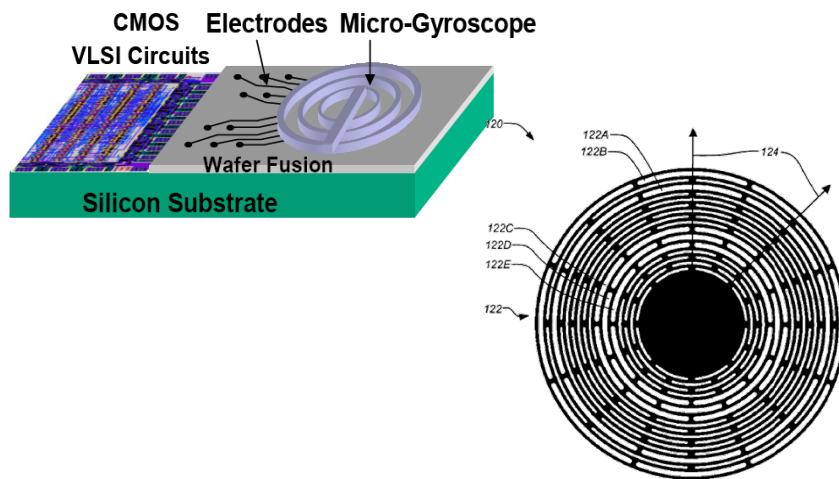

## Disc Resonating Gyro Basics

- Gyroscope is driven to resonate in-plane
- Electrodes sense deflection in outer ring sockets
- Electrodes actuate in inner ring sockets
- Circuits process the signal and feedback into the system

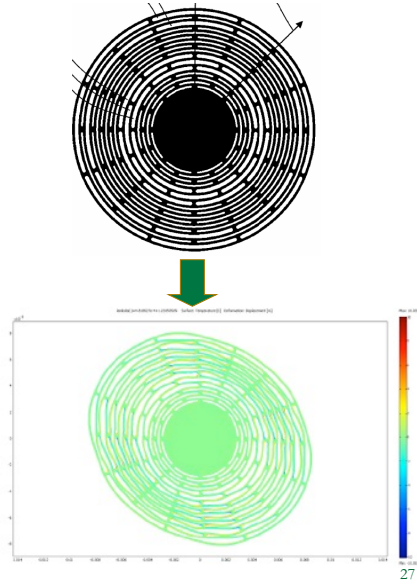

CSE/EE 474

## Operation Principle of the DRG

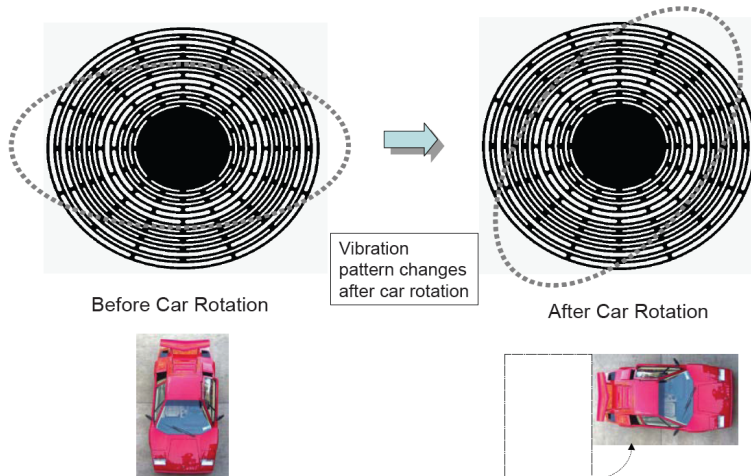

Courtesy of Boeing, US Patent: 7,040,163, May 9, 2006

CSE/EE 474

28

## Coriolis Effect

- Coriolis acceleration ( $a$ ) occurs if a resonating disc is perturbed
- Depends on velocities on the disc → higher frequencies allow Coriolis acceleration to dominate centrifugal acceleration
- Coriolis acceleration is what the electrodes sense through change in capacitance

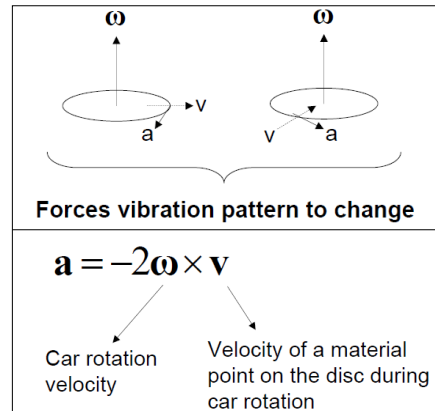

## How Does the DRG Work?

- DC Source creates an electrostatic force that moves the disc
- Proper control of these electrodes can put the system into resonance
- Similarly, the sensing electrodes use gap changes to gauge system changes

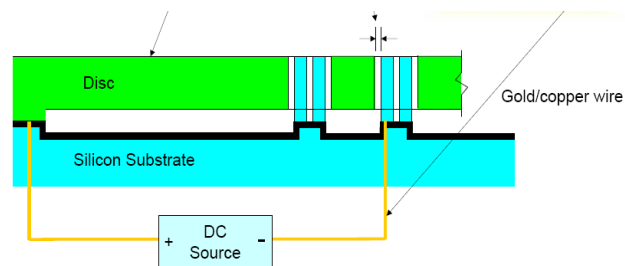

## One Ring or Many?

- One major advantage of this system is its large area
- Compared to a single ring gyro, has much more control over actuation and sensing
- Single rings require flexible support beams as well

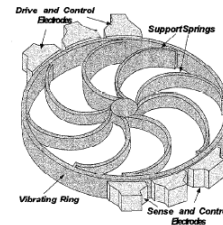
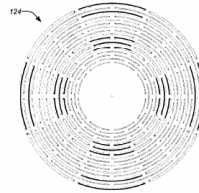

## Why Cut the Circles?

- With full concentric circles, the structure tends to be rigid
- By using arcs instead, the structure becomes more flexible, allowing for better accuracy and performance

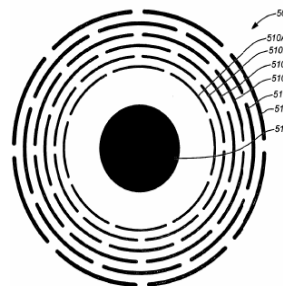



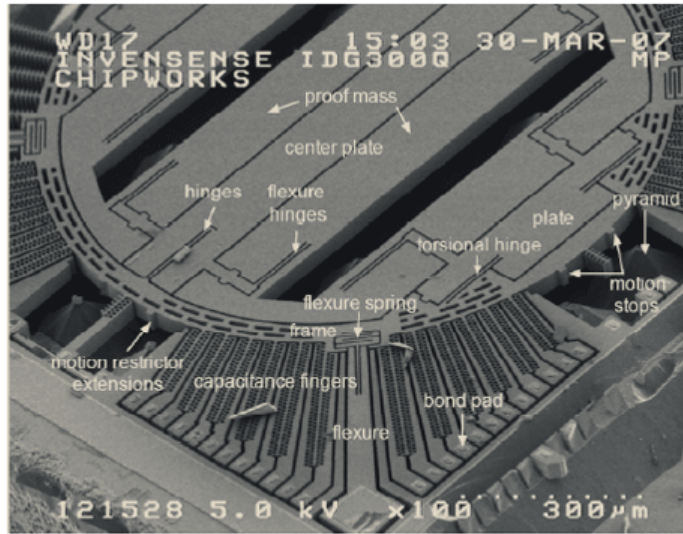

2. Coriolis gyros needn't use a linear configuration. Detecting angular rotation with the Coriolis effect simply requires a structure that's forced to vibrate normally at its resonant frequency. This is a microphotograph of the InvenSense IDG300 MEMS gyro, which uses a vibrating ring.

CSE/EE 474

33

## Invensense MPU-6050 6-axis gyroscope and accelerometer

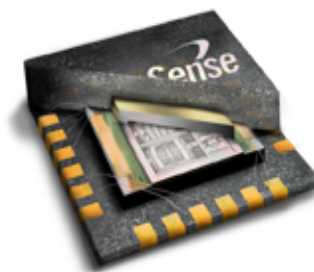

4 x 4 x 1 mm

CSE/EE 474

34

# MPU-6050

Supply voltage of  
2.375V – 3.46V

Current of 3.9mA

Uses an I2C bus

Selectable  
gyroscope and  
accelerometer  
ranges

1MHz internal clock

## 7.5 Block Diagram

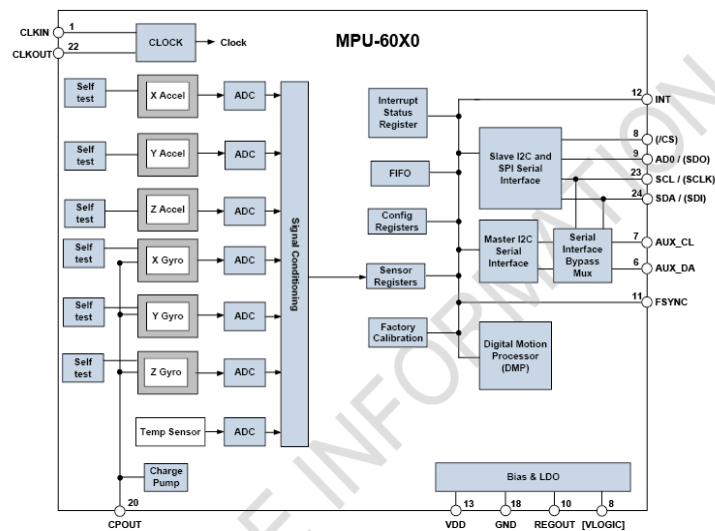

## Sample MPU-6050 data

- The accelerometer and gyroscope measurements are explained in the MPU-6050 datasheet in the GYRO\_CONFIG and ACCEL\_CONFIG register descriptions (sections 4.4 and 4.5 on pages 14 and 15).
- The scale of each depends on the sensitivity settings chosen
  - +/- 2, 4, 8, or 16g for the accelerometer
  - +/- 250, 500, 1000, or 2000 deg/sec for the gyroscope.
- The accelerometer produces data in units of **acceleration** (distance over time<sup>2</sup>)
- The gyroscope produces data in units of **rotational velocity** (rotation distance over time).

## Sample MPU-6050 data

- The output scale for any setting is [-32768, +32767] for each of the six axes. The default setting in our example is +/- 2g for the accel and +/- 250 deg/sec for the gyro.
- If the device is perfectly level and not moving, then:
  - X/Y accel axes should read 0
  - Z accel axis should read 1g, which is +16384 at a sensitivity of 2g
  - X/Y/Z gyro axes should read 0
- In reality, the accel axes won't read exactly 0 since it is difficult to be perfectly level and there is some noise/error, and the gyros will also not read exactly 0 for the same reason (noise/error).

# Sample MPU-6050 data

MPU6050 is online...

x-axis self test: acceleration trim within : 0.6% of factory value

y-axis self test: acceleration trim within : 0.6% of factory value

z-axis self test: acceleration trim within : 0.7% of factory value

x-axis self test: gyration trim within : 0.2% of factory value

y-axis self test: gyration trim within : -0.2% of factory value

z-axis self test: gyration trim within : 0.3% of factory value

MPU6050 initialized for active data mode....

X-acceleration: -3.30 mg Y-acceleration: 1.71 mg Z-acceleration: 1005.68 mg

X-gyro rate: -1.9 degrees/sec Y-gyro rate: 0.3 degrees/sec Z-gyro rate: -0.3 degrees/sec

Temperature is 13.31 degrees C

X-acceleration: 14.40 mg Y-acceleration: 0.98 mg Z-acceleration: 1003.36 mg

X-gyro rate: 0.4 degrees/sec Y-gyro rate: 0.1 degrees/sec Z-gyro rate: 0.0 degrees/sec

Temperature is 23.27 degrees C

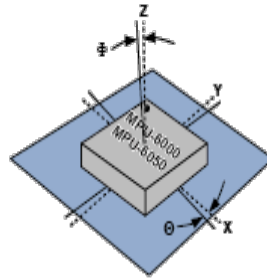

Package Gyro & Accel Axes (---) Relative to PCB Axes (—) with Orientation Errors ( $\theta$  and  $\phi$ )

The table below shows the cross-axis sensitivity as a percentage of the gyroscope or accelerometer's sensitivity for a given orientation error, respectively.

**Cross-Axis Sensitivity vs. Orientation Error**

Orientation Error ( $\theta$ or $\phi$ )	Cross-Axis Sensitivity ( $\sin\theta$ or $\sin\phi$ )
0°	0%
0.5°	0.87%
1°	1.75%

The specifications for cross-axis sensitivity in Section 6.1 and Section 6.2 include the effect of the die orientation error with respect to the package.